

Upgrade firmware of Ewon[®] Cosy+ devices
PRODUCT TYPE: COSY+, TALK2M PRO

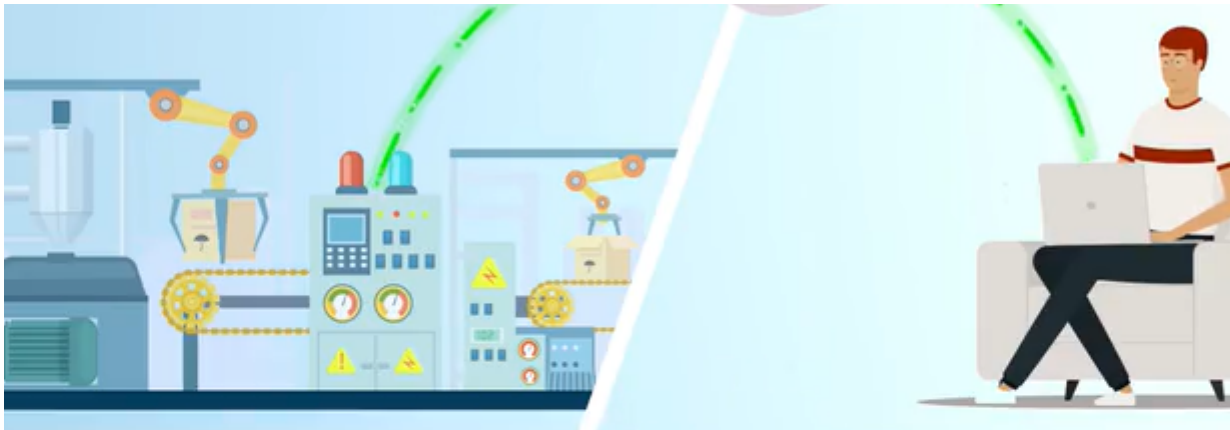

Important User Information

Disclaimer

The information in this document is for informational purposes only. Please inform HMS Networks of any inaccuracies or omissions found in this document. HMS Networks disclaims any responsibility or liability for any errors that may appear in this document.

HMS Networks reserves the right to modify its products in line with its policy of continuous product development. The information in this document shall therefore not be construed as a commitment on the part of HMS Networks and is subject to change without notice. HMS Networks makes no commitment to update or keep current the information in this document.

The data, examples and illustrations found in this document are included for illustrative purposes and are only intended to help improve understanding of the functionality and handling of the product. In view of the wide range of possible applications of the product, and because of the many variables and requirements associated with any particular implementation, HMS Networks cannot assume responsibility or liability for actual use based on the data, examples or illustrations included in this document nor for any damages incurred during installation of the product. Those responsible for the use of the product must acquire sufficient knowledge in order to ensure that the product is used correctly in their specific application and that the application meets all performance and safety requirements including any applicable laws, regulations, codes and standards. Further, HMS Networks will under no circumstances assume liability or responsibility for any problems that may arise as a result from the use of undocumented features or functional side effects found outside the documented scope of the product. The effects caused by any direct or indirect use of such aspects of the product are undefined and may include e.g. compatibility issues and stability issues.

Copyright © 2022 HMS Networks

Table of Contents

1. Introduction	1
2. Automatic Firmware Update	2
3. Talk2m Firmware Management (Talk2m Pro only)	4
4. Manual Firmware Update	8
5. Alternative ways to update your Ewon® Cosy+	11
5.1. Update by SD Card/USB drive	11
5.2. Upgrade by FTP	12
5.3. Downgrade with .upkg File	14

1. Introduction

Keeping an Ewon device's firmware updated helps protect it against known security threats and gives you access to the latest fixes and features.

There are several different ways to update your Ewon device's firmware to make it easy to keep it up to date.

This document is for Ewon® Cosy+ devices. For other Ewon devices, see our [Knowledge base](#).

**NOTE**

A firmware update on an Ewon® Cosy+ first involves transferring a firmware file to the Ewon® Cosy+.

When the Ewon® Cosy+ receives the file, the update is applied and the Ewon® Cosy+ reboots. During the reboot, communication through the Ethernet switch of the Ewon® Cosy+ will be temporarily interrupted.

2. Automatic Firmware Update

The Ewon® Cosy+ offers an embedded Firmware Update feature inside its web interface. From this option, you can configure the Ewon® Cosy+ to automatically retrieve and apply firmware updates. The **Automatic Firmware Update** feature allows you to keep your Ewon® Cosy+ up to date without any user intervention.

The Ewon® Cosy+ can be configured to:

- Apply only security patches
- Apply the most recent official release
- Apply the most recent release including pre-release firmware



NOTE

Pre-release firmware should be applied only to units for testing purposes unless told otherwise by a support representative.

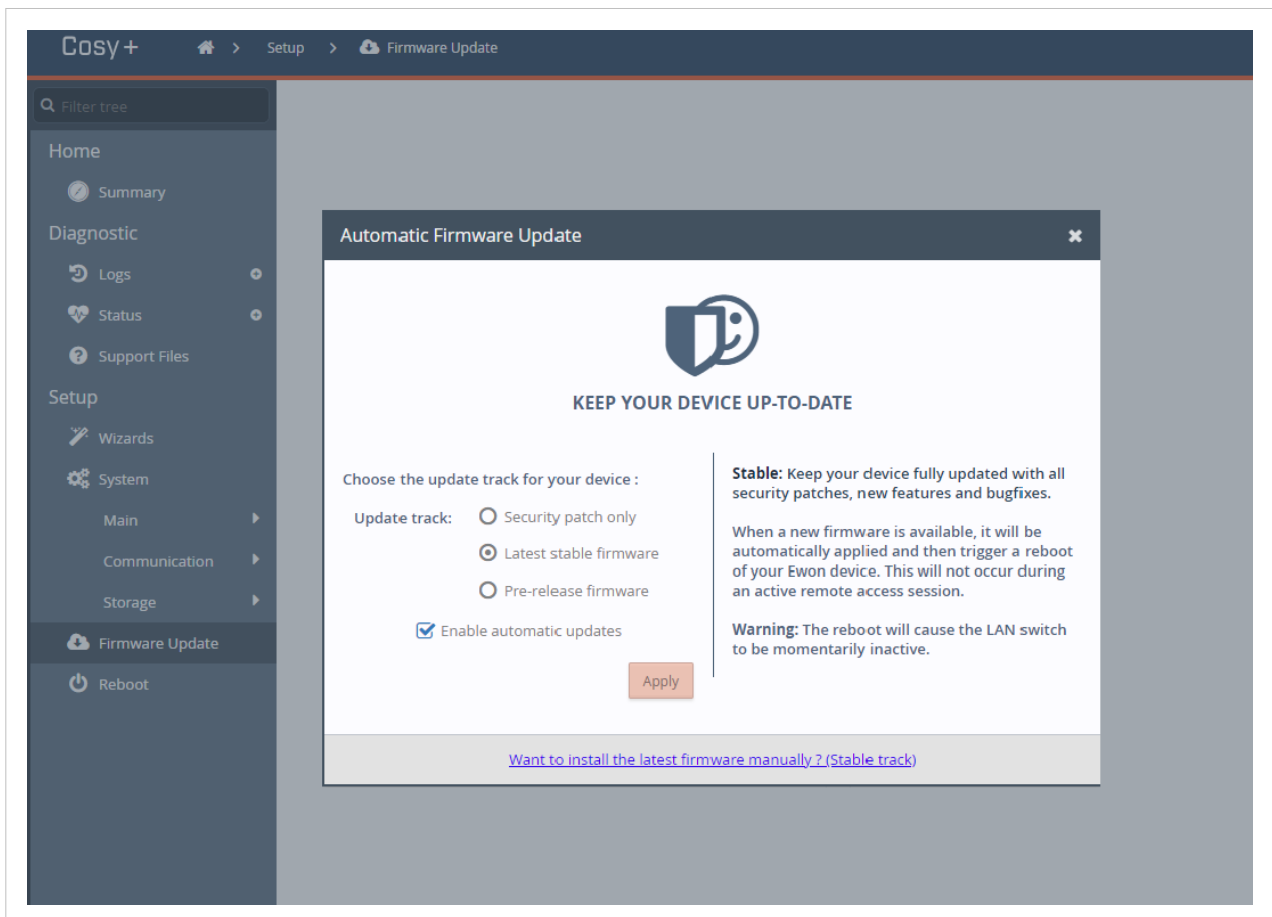

The Ewon® Cosy+ will perform a reboot automatically after each automatic firmware update.



NOTICE

The automatic firmware update check occurs every 24 hours from the boot time and the firmware is automatically installed without any confirmation.

Every day the Ewon® Cosy+ checks if a new firmware (for the selected track) is available on the <https://deviceupdate.talk2m.com> endpoint. The reboot will never occur when a remote user is connected to the Ewon® Cosy+. When the update process starts, it checks first if someone is connected at the same time. If yes, it cancels the operation and will wait for the next day to start the process.

Check our [KB-0209-00 - Adresses and ports used by Talk2m](#) for more information.

To enable the automatic firmware update feature, follow the procedure below:

1. Use the radio buttons to **select** the update track for your device.
2. **Check** the *Enable automatic updates* box.
3. Click **Apply**

**NOTE**

You can decide whether or not to use the automatic update and choose to trigger it from Ecatcher instead through the Firmware Management feature in your Talk2m pro (only). You can find more info on our [Ecatcher Online Help](#).

3. Talk2m Firmware Management (Talk2m Pro only)

You can easily keep all your Ewon Cosy+ devices up to date using the Talk2m Firmware Management feature in Ecatcher.

With the Firmware Management feature, account administrators can:

- Quickly see which Ewon® Cosy+ devices need security updates or are running older firmware versions. You can apply filters to display only those devices that can have security patches or newer firmware versions applied. Also, icons in the **Firmware** column identify devices in need of special attention.
- Control which firmware versions are applied. Some organizations require new firmware to be internally qualified before being applied. With the Firmware Management feature, you can apply the latest firmware version or a specific earlier firmware version.
- Update the firmware of multiple Ewon® Cosy+ devices at the same time. You can quickly protect all your equipment when new security patches become available.
- Control when firmware updates are applied. Administrators can apply updates at times when the reboot associated with a firmware update will not interfere with normal operations.



NOTICE

The Ewon® Cosy+ reboots during the upgrade process, with this feature you can choose when it will be the best time to perform it.

The Firmware Management feature requires Ecatcher version 6.10 or higher and Ewon® Cosy+ firmware version 21.1s1 or higher.



TIP

To control which firmware versions are applied and when they are applied, be sure the Automatic Firmware Update feature on the Ewon® Cosy+ is **NOT** enabled. The **Auto-update** column in Ecatcher displays **Yes** if the Automatic Firmware Update feature is enabled.

To use the Firmware Management feature:

1. Launch Ecatcher.
2. Log in using your Talk2m account credentials.
3. Click the **Firmware** button from the left side menu.
4. Select the Ewon® Cosy+ devices you wish to upgrade. Use Shift+click or Ctrl+click to select multiple devices.

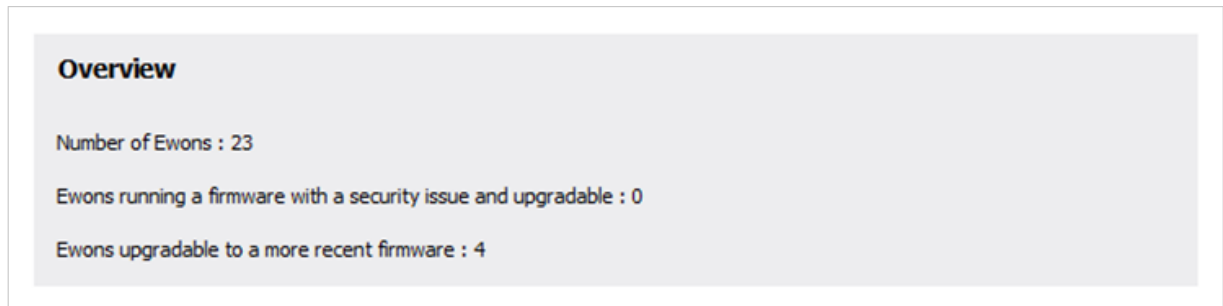

The **Overview** section of the screen gives you a summary of how many devices require a security patch or can be updated to a newer firmware version.

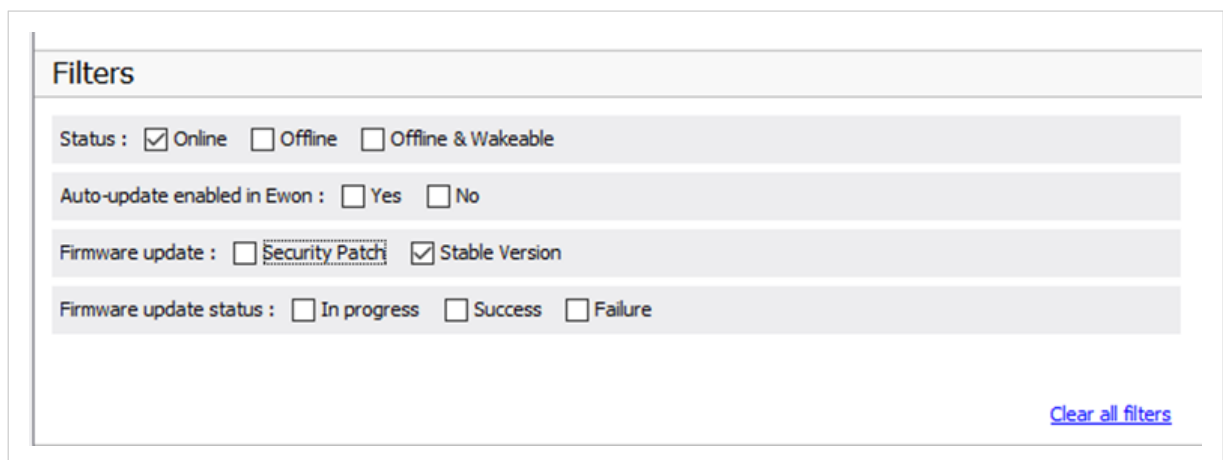

The **Filters** section lets you restrict the displayed Ewon devices to make it easier to find the ones you want.

5. Click the **Update Firmware** button. A dialog box appears.

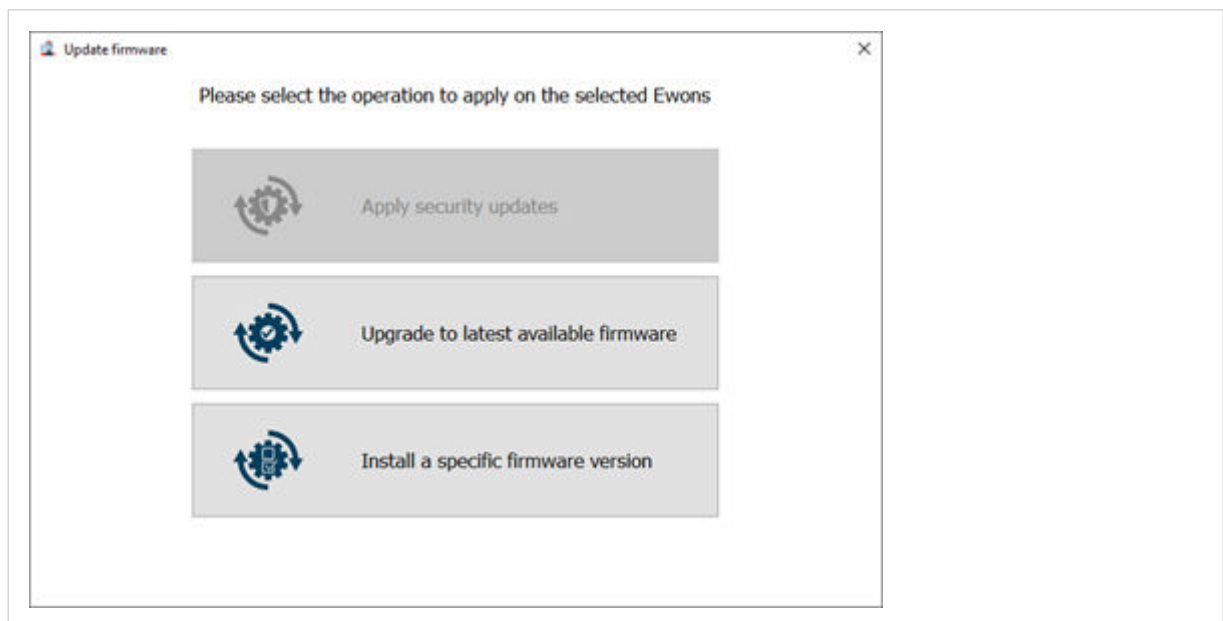

6. When the dialog box appears, select the correct operation. You can:
 - a. Apply security updates (if available)
 - b. Update to the latest available firmware (if available)

- c. Install a specific firmware version. In this option, you are prompted to select which firmware version to apply. You can use this option to update to a firmware version that is not the latest, update to a pre-release firmware version, or downgrade the firmware.

**NOTE**

Pre-release firmware should be applied only to units for testing purposes unless told otherwise by a support representative.

7. Click the **Update Firmware** button. A dialog box appears to show the status of your firmware update requests. Communication errors or problems transferring the firmware file appear here.
8. Click the **Close** button to return to the main firmware management screen.
9. Click **Refresh** to update the **Current Update Status** column to watch the firmware update progress.

The screenshot displays the 'Ewon Properties: Test_' interface. At the top, there are navigation buttons: 'Back to Ewons', 'Talk2m Connectivity', 'Duplicate', 'Delete', and 'Disable'. Below this, there are fields for 'Country:', 'IP address:', and 'This Ewon serial number is :'. A 'Modify...' button is next to the serial number field. To the right is a map of Belgium and surrounding areas with a 'Help' link. The 'VPN' section shows 'ONLINE since 11/01/24, 09:42:05 with vpn IP' and 'Ewon connects using a permanent connection.' with a 'Modify...' button. The 'LAN & Firewall' section shows 'Ewon LAN: 192...' and buttons for 'Configure LAN Devices & Firewall...' and 'Modify LAN Subnet...'. The 'Firmware' section, highlighted with a green border, shows 'The Ewon runs the following firmware: 21.2s4', 'Firmware auto-update is disabled.', and 'Firmware upgrade status : UNKNOWN'. An 'Update Firmware' button is located at the bottom right of this section. A 'Show advanced settings...' link is at the bottom left.

You can also update the firmware of an individual Ewon® Cosy+ from its Properties page.

4. Manual Firmware Update

Embedded Firmware Update Feature

The Ewon® Cosy+'s **Firmware Update** feature can also be used to manually update the Ewon® Cosy+.

To manually install an update:

1. Use the radio buttons to select the firmware version to apply. You can choose:
 - a. The latest security patches
 - b. The latest official firmware version
 - c. The latest firmware version including pre-release versions
2. Click the link at the bottom of the **Automatic Firmware Update** window.

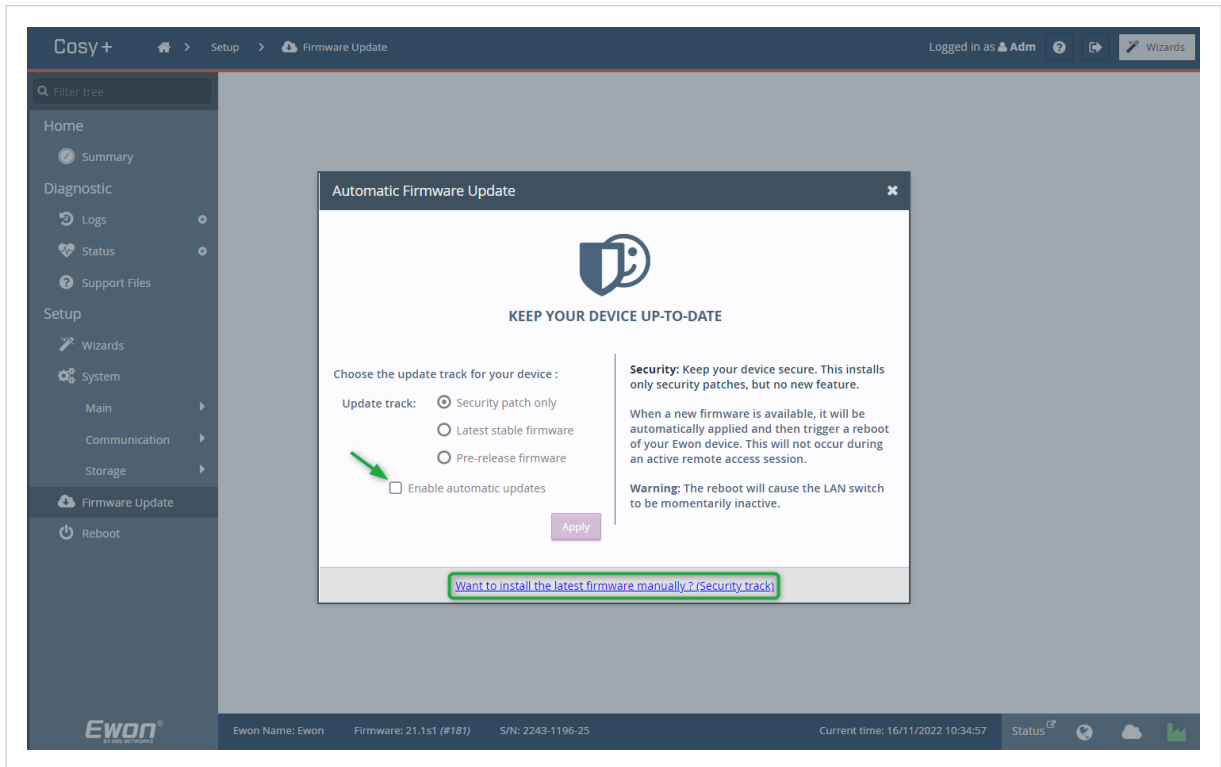

3. A prompt will appear and ask you to confirm that you want to complete the update process.

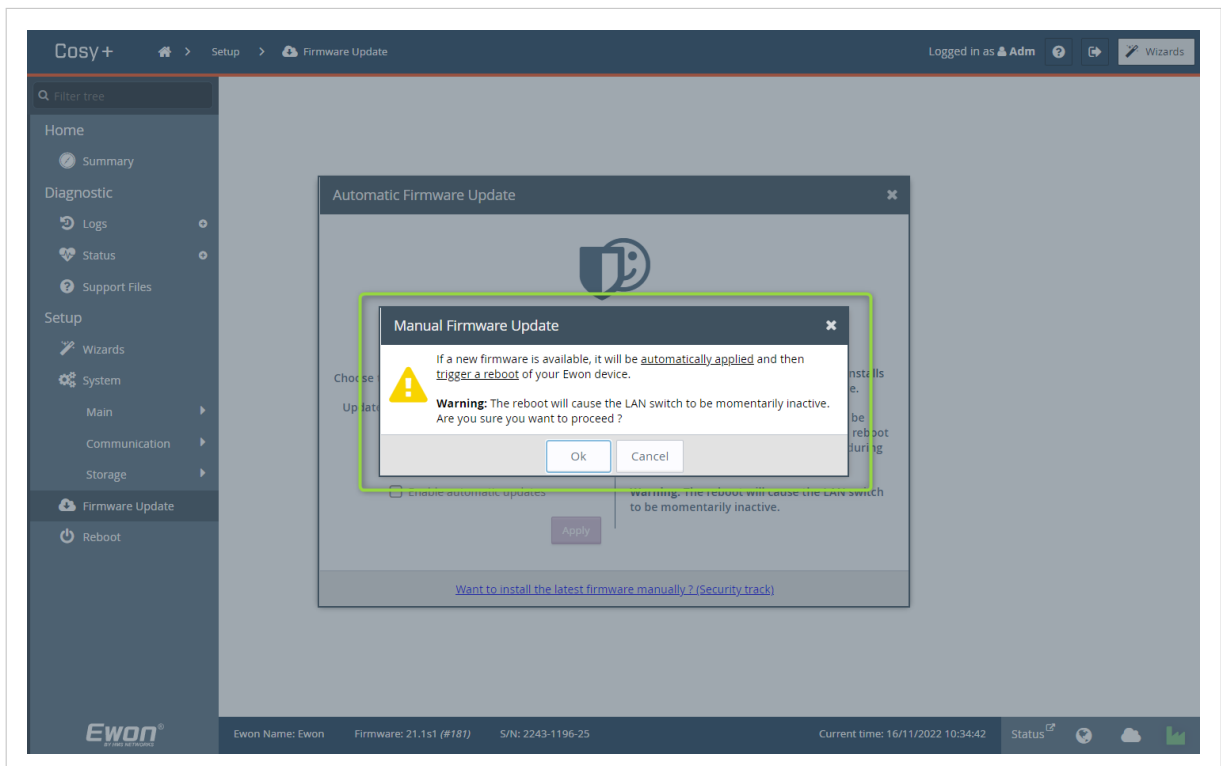

The upgrade process includes a reboot of the Ewon® Cosy+ at the end. If you are connected to the Ewon® Cosy+ remotely, you will be disconnected.

5. Alternative ways to update your Ewon® Cosy+

Under certain circumstances, you might not be able to use any of the firmware update methods explained above.

For example, if you need to update your Ewon® Cosy+ when it has no internet access, you will need a different method to transfer the firmware update to your Ewon® Cosy+.

Alternative ways exist to upgrade or downgrade the firmware of your Ewon Cosy+. However, these methods take more time and effort than the methods previously described.



WARNING

You must use caution to **not disrupt power during the upgrade process** or your device may become unusable.

5.1. Update by SD Card/USB drive

The firmware files required for updating using an SD card/USB drive can be retrieved from the [Ewon firmware website](#), go to the section *Support and downloads > Firmware*.



TIP

From the website, you can either download a simple firmware update file or a file that can be used to both update the firmware and perform a factory reset of the Ewon device.

You will need to reconfigure your Ewon® Cosy+ after applying the factory reset version.

1. Download the latest firmware file to your PC.
2. Rename the file `ewon.upkg`. If the file is not named **ewon.upkg**, the Ewon® Cosy+ will not recognize it as a firmware update file.
3. **USB stick needs to be FAT32 formatted.**
Insert the SD card/USB drive into the appropriate port or reader of your PC.
4. Copy the firmware file to the SD card/USB drive.
5. Remove the SD card/USB drive from your reader.
6. Insert the SD card/USB drive into the powered off Ewon device.

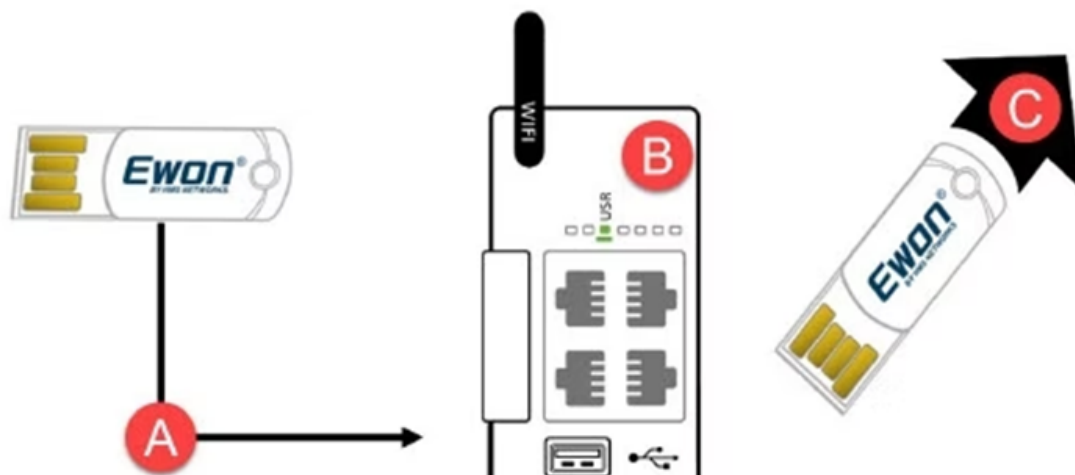

7. With the SD card/USB drive inserted, power on the Ewon device.
8. Check the USR LED.
The USR LED will flash orange to indicate it is processing the firmware file. **DO NOT** power **OFF** the Ewon® Cosy+ during this process or this could make it unusable. When the file is processed, the USR LED will turn solid green. This process can take several minutes.
9. When the USR LED is solid green, remove the SD card/USB drive and reboot the Ewon device.

5.2. Upgrade by FTP

The Ewon device's firmware can also be upgraded using FTP.

From the website, you can either download a simple firmware update file or a file that can be used to both update the firmware and perform a factory reset of the Ewon® Cosy+Ewon device. You will need to reconfigure your Ewon® Cosy+ after applying the factory reset version.

You can do this using any FTP client software, but be sure that the FTP client is using binary transfer mode and not ASCII transfer mode.

1. Download the correct firmware file for your Ewon model from the [Ewon firmware website](#). You will need to reconfigure your Ewon® Cosy+ after applying the factory reset version.
2. Rename the firmware file **ewon.upkg**. If the file is not named ewon.upkg, the Ewon® Cosy+ will not recognize it as a firmware update file.
3. Connect to your Ewon device. This can be either through a local connection or through a remote connection using Ecatcher.

**NOTE**

Do not use a remote connection if applying the factory reset version.

4. Open your FTP client software. Use the Ewon device's LAN IP address as the FTP server address and the **adm** user's credentials as the login credentials.

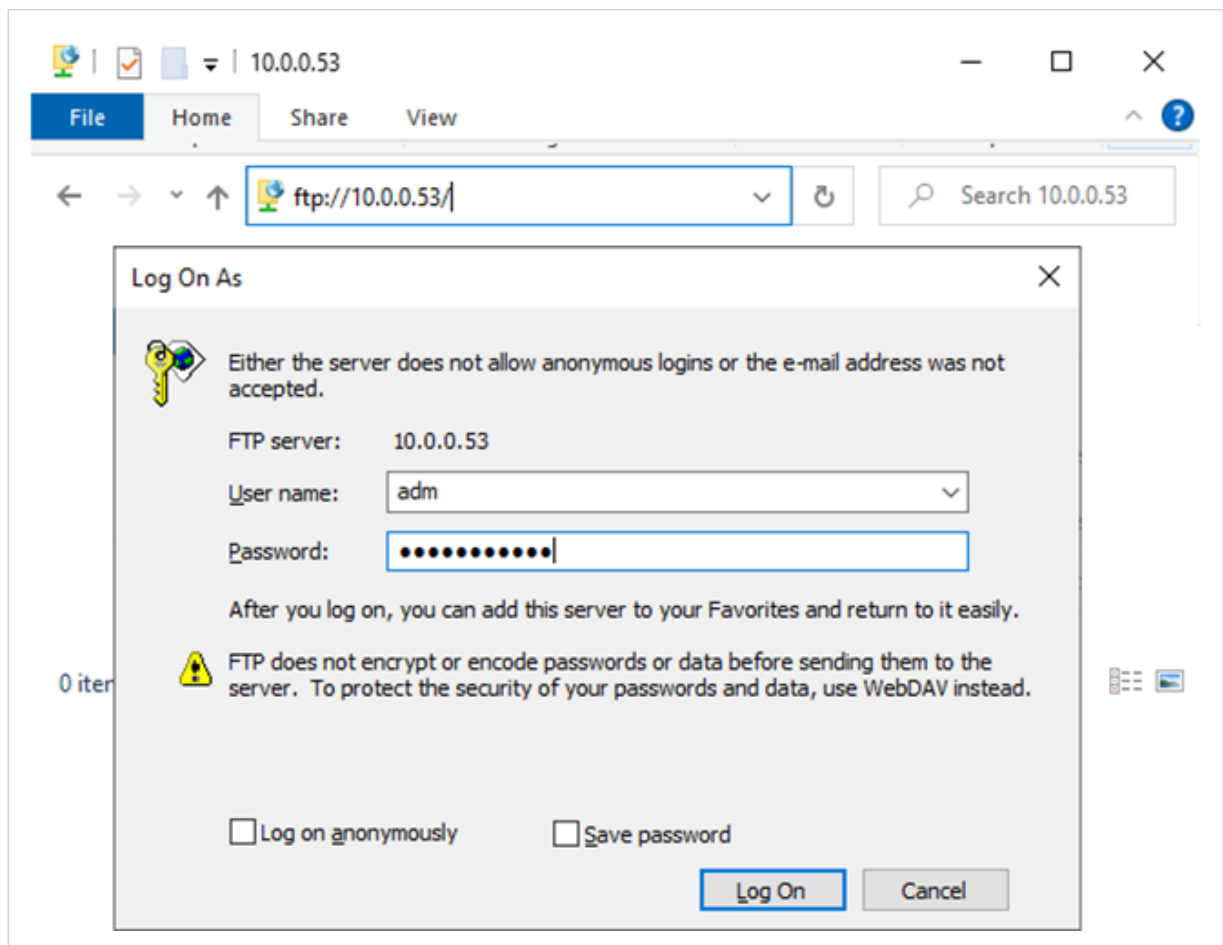

5. Drag the new firmware to be uploaded and drop it to the root of the Ewon device's file system. A confirmation window may appear asking you the action to be performed. If so, confirm that you want to overwrite the existing file.
6. Once the file transfer is complete, close the connection between the FTP client and the Ewon device. Depending on your FTP client, this could mean clicking a disconnect button or closing the application.

After a few moments, the Ewon® Cosy+ will automatically reboot. When it boots, the USR LED will flash orange to indicate it is processing the firmware file. This process may take several minutes.

**WARNING**

DO NOT power OFF the Ewon® Cosy+ during this process or this could make it unusable.

Once it has applied the new firmware file, the Ewon® Cosy+ will continue the boot process.

When the Ewon® Cosy+ has fully booted, the USB LED will slowly flash green.

5.3. Downgrade with .upkg File

To perform a downgrade on a Ewon® Cosy+, follow the procedure for upgrading the firmware through FTP or with an SD card/USB drive, but use a firmware version lower than the currently running version.

The firmware downgrade erases the whole configuration of your Ewon® Cosy+.